



DES PDM 24



Cable entry plates with internal frame and double membrane



FEATURES

- For large number of cables without connectors
- High strain relief thanks to the double membrane
- Cost efficient solution
- IP66 and Nema 4X* certified
- ATEX version on request (see group 7)
- Threaded inserts version on request

The DES PDM 24 is an innovative alternative to standard cable glands on electrical, electronic and telecommunication cabinets and equipment. The cable is pushed through the front membrane, whilst the second membrane increases the strain relief and liquid resistance.

Material: TPE, halogens and silicones free

Flammability: self-extinguishing acc. to UL94-V0

Temperature: -40°C... +110°C (static)

RELATED PRODUCTS

- IFP plugs (page 92)
- DES PDM caps (page 92)
- HY360 hydraulic punch driver (page 139)
- PF/PFX cable entry system plates (from page 140)

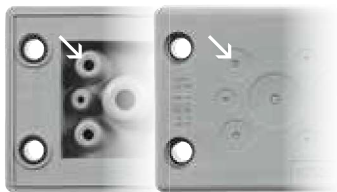

Double parallel membrane

	Model	Code	Nr. Cables	Ø Cable min/max (mm)	Dimensions (mm)		Pcs (/pack)
					Cut-out	Plate	
NEW	DES PDM 24/3G	1732012403	3	18 / 26	112 x 36	148,6 x 59,6	10
	DES PDM 24/12G	1732012412	12	9 / 16			
DES PDM 24/14G	1732012414	10	2,8 / 6,5 14,5 / 22				
DES PDM 24/15G	1732012415	15	6,8 / 12				
DES PDM 24/16G	1732012416	8	2,8 / 6,5				
		4	4,4 / 9,7				
		2	8,6 / 16,2				
DES PDM 24/17G	1732012417	6	2,8 / 6,5				
		6	4,6 / 10,2				
DES PDM 24/25G	1732012425	5	8,6 / 16,2				
		12	2,8 / 6,5				
NEW	DES PDM 24/26G	1732012426	7	4,4 / 9,7			
			6	6,8 / 12			
DES PDM 24/32G	1732012432	26	4,6 / 10				
		21	2,8 / 6,5				
DES PDM 24/42G	1732012442	8	4,6 / 10,2				
		3	6,8 / 12				
DES PDM 24/124G	1732012421	42	2,8 / 6,5				
		120	1,75/4,7 2,3/6				

Dimensions (mm)

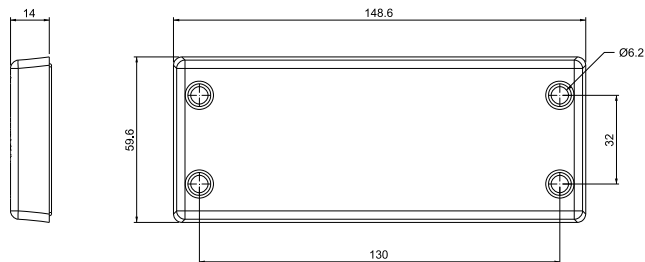

* Indoor only



IP66
IP68

NEMA
12, 4X*

UL TYPE
12, 4X



ECOLAB



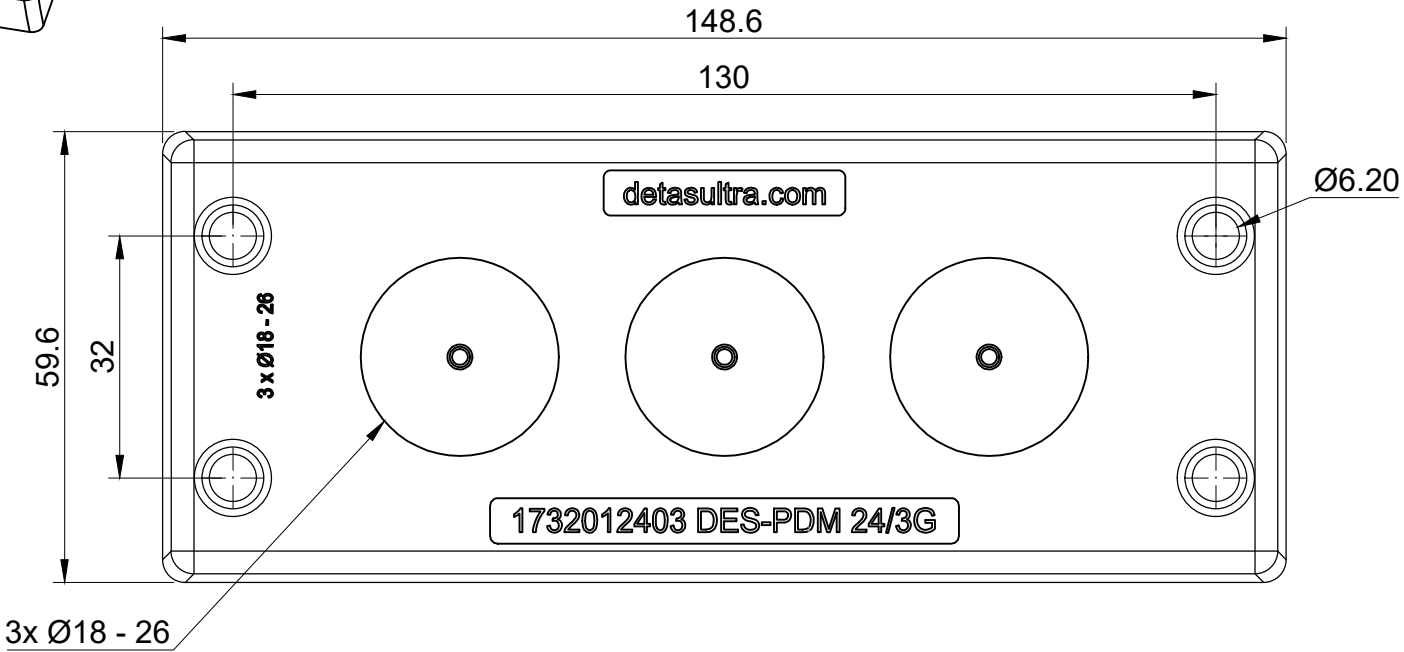
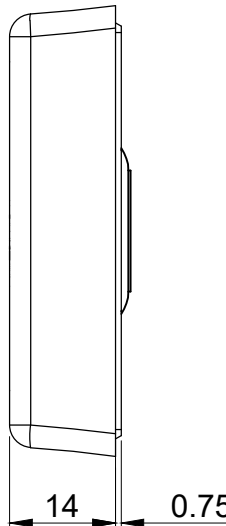
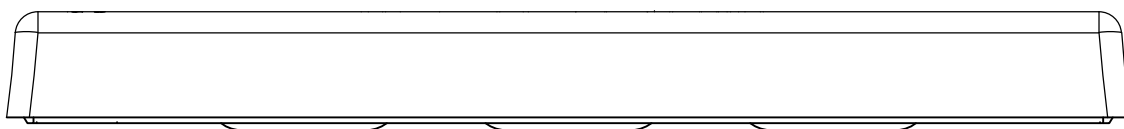
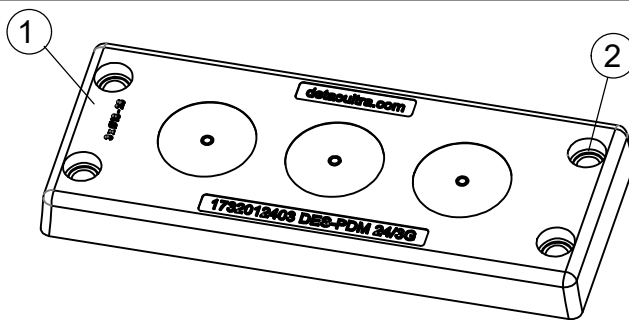

Id	Description	Material	Q.ty
1	Body	TPE	1
2	Internal frame	PA	1

Flammability: UL94-V0, self-extinguishing
Temperature: -40°C ... +105°C
Properties: halogen-free, silicone-free

Recommended cut-out:
 112 x 36 mm

Black color version:
 DES-PDM-24/14B: 1732013403

 Threaded inserts version:
 DES-PDM-24/14G FT: 1732212403

 ATEX grey version:
 DES-PDM-24A/14G: 1732312403

 ATEX black version:
 DES-PDM-24A/14B: 1732313403

Codice / Code		1732012403			Descrizione / Description			DES PDM 24/3G		Rev.	000
Materiale / Material	See table	Colore / Color	Grey	Peso / Weight (g)	-	Unità di misura / Measure units	mm	Formato / Format	A4	Scala / Scale	1:1
 www.detasultra.com <small>QUESTO DISEGNO E LE SUE INFORMAZIONI SONO STRETTAMENTE RISERVATE DI PROPRIETA' DETAS SPA. NON UTILIZZARE PER SCOPI DIVERSI DA QUELLI PER CUI SONO STATE FORNITE. DO NOT SCALE DRAWING.</small>					Data / Date	01/02/2024		Numero foglio / Sheet number	-		
					Disegn. / Drawn	Pozzi F.		Note / Notes	-		

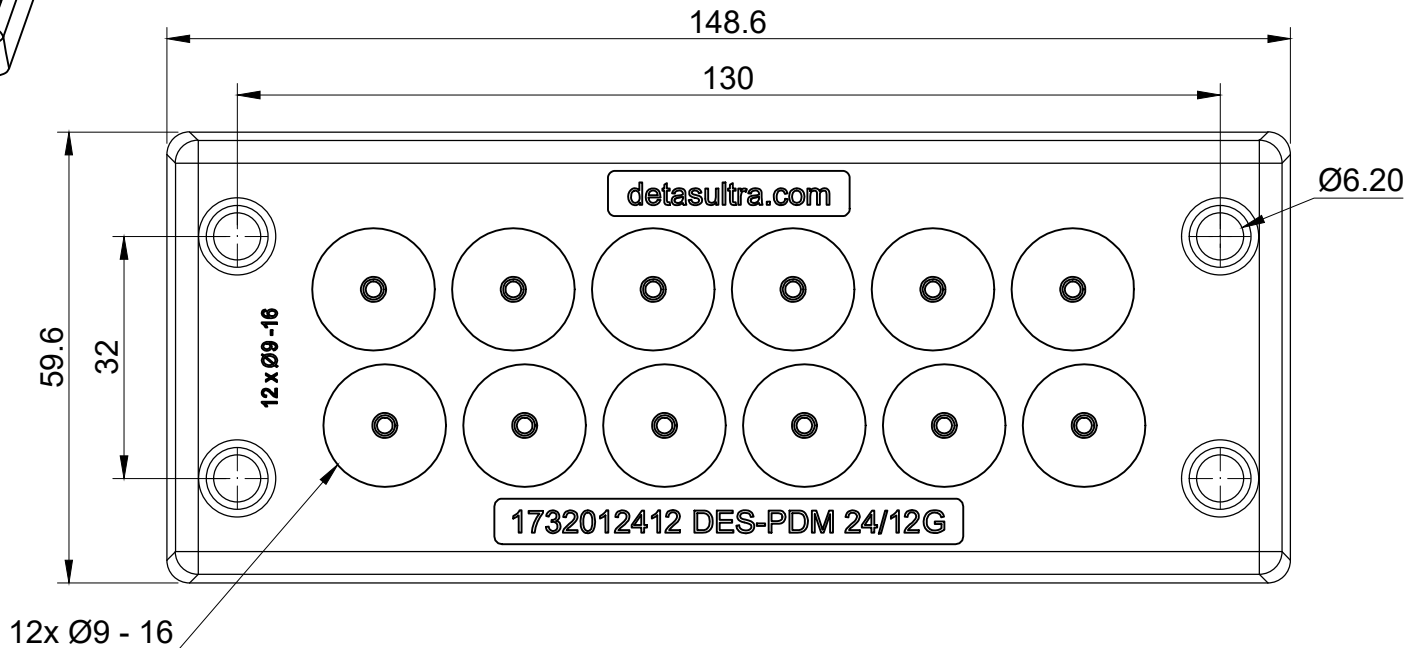
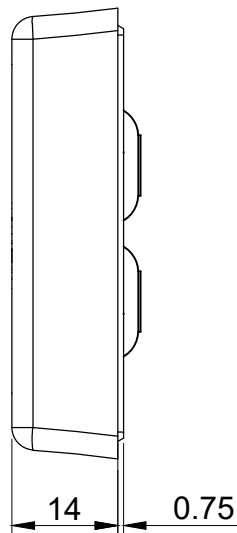
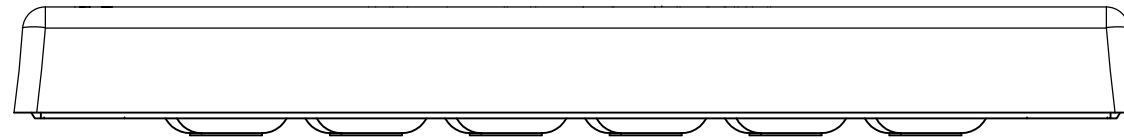
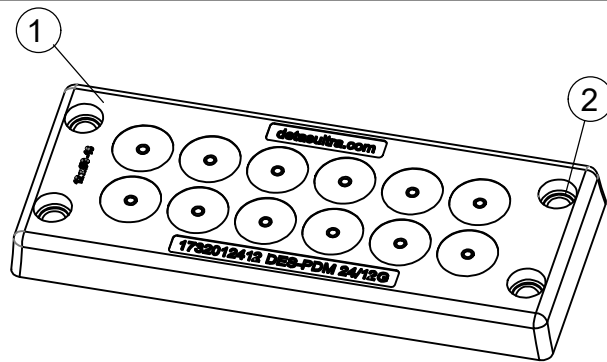

Id	Description	Material	Q.ty
1	Body	TPE	1
2	Internal frame	PA	1

	IP66	NEMA 12, 4X	UL TYPE 12, 4X							
--	-------------	--------------------	-----------------------	--	--	--	--	--	--	--

Flammability: UL94-V0, self-extinguishing
Temperature: -40°C ... +105°C
Properties: halogen-free, silicone-free

Recommended cut-out:
112 x 36 mm



Black color version:
DES-PDM-24/14B: 1732013412

Threaded inserts version:
DES-PDM-24/14G FT: 1732212412

ATEX grey version:
DES-PDM-24A/14G: 1732312412

ATEX black version:
DES-PDM-24A/14B: 1732313412

Codice / Code

1732012412

Descrizione / Description

DES PDM 24/12G

Rev.

000

Materiale / Material

See table

Colore / Color

Grey

Peso / Weight (g)

-

Unità di misura / Measure units

mm

Formato / Format

A4

Scala / Scale

1:1



QUESTO DISEGNO E LE SUE INFORMAZIONI SONO STRETTAMENTE RISERVATE DI PROPRIETÀ DETAS SPA.
NON UTILIZZARE PER SCOPI DIVERSI DA QUELLI PER CUI SONO STATE FORNITE. DO NOT SCALE DRAWING.

Data / Date

01/02/2024

Numero foglio / Sheet number

-

Numero progetto / Project number

-

Disegn. / Drawn

Pozzi F.

Note / Notes

-

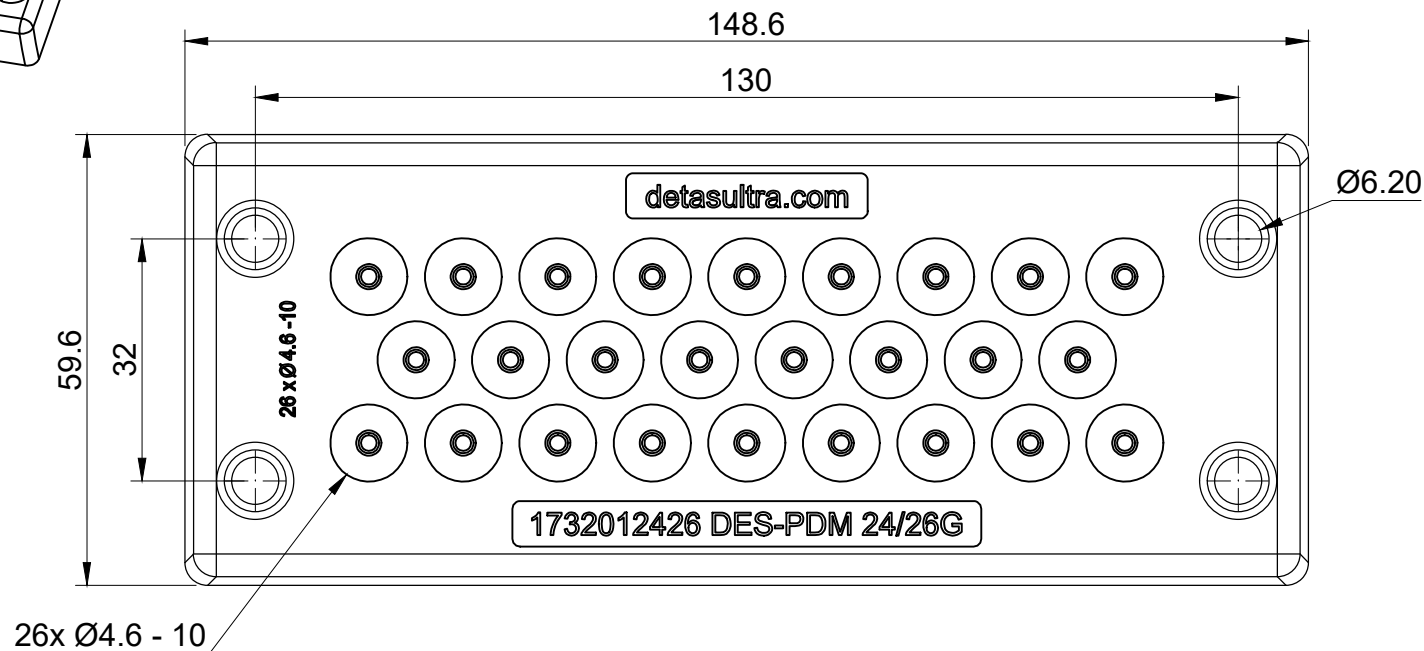
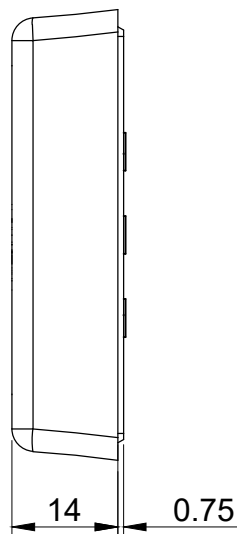
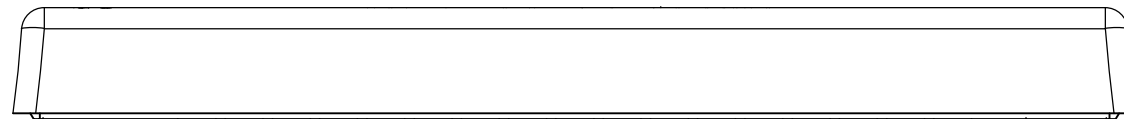
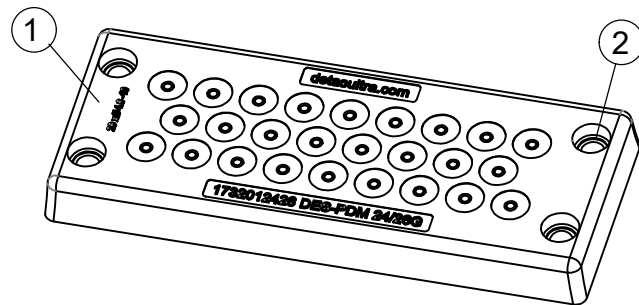

Id	Description	Material	Q.ty
1	Body	TPE	1
2	Internal frame	PA	1

Flammability: UL94-V0, self-extinguishing
Temperature: -40°C ... +105°C
Properties: halogen-free, silicone-free

Recommended cut-out: 112 x 36 mm

Black color version: DES-PDM-24/14B: 1732013426		Codice / Code 1732012426		Descrizione / Description DES PDM 24/26G			Rev. 000	
Threaded inserts version: DES-PDM-24/14G FT: 1732212426		Materiale / Material See table	Colore / Color Grey	Peso / Weight (g) -	Unità di misura / Measure units mm	Formato / Format A4	Scala / Scale 1:1	
ATEX grey version: DES-PDM-24A/14G: 1732312426		 www.detasultra.com <small>QUESTO DISEGNO E LE SUE INFORMAZIONI SONO STRETTAMENTE RISERVATE DI PROPRIETÀ DETAS SPA. NON UTILIZZARE PER SCOPI DIVERSI DA QUELLI PER CUI SONO STATE FORNITE. DO NOT SCALE DRAWING.</small>			Data / Date 01/02/2024	Numero foglio / Sheet number -	Numero progetto / Project number -	
ATEX black version: DES-PDM-24A/14B: 1732313426					Disegn. / Drawn Pozzi F.	Note / Notes -		

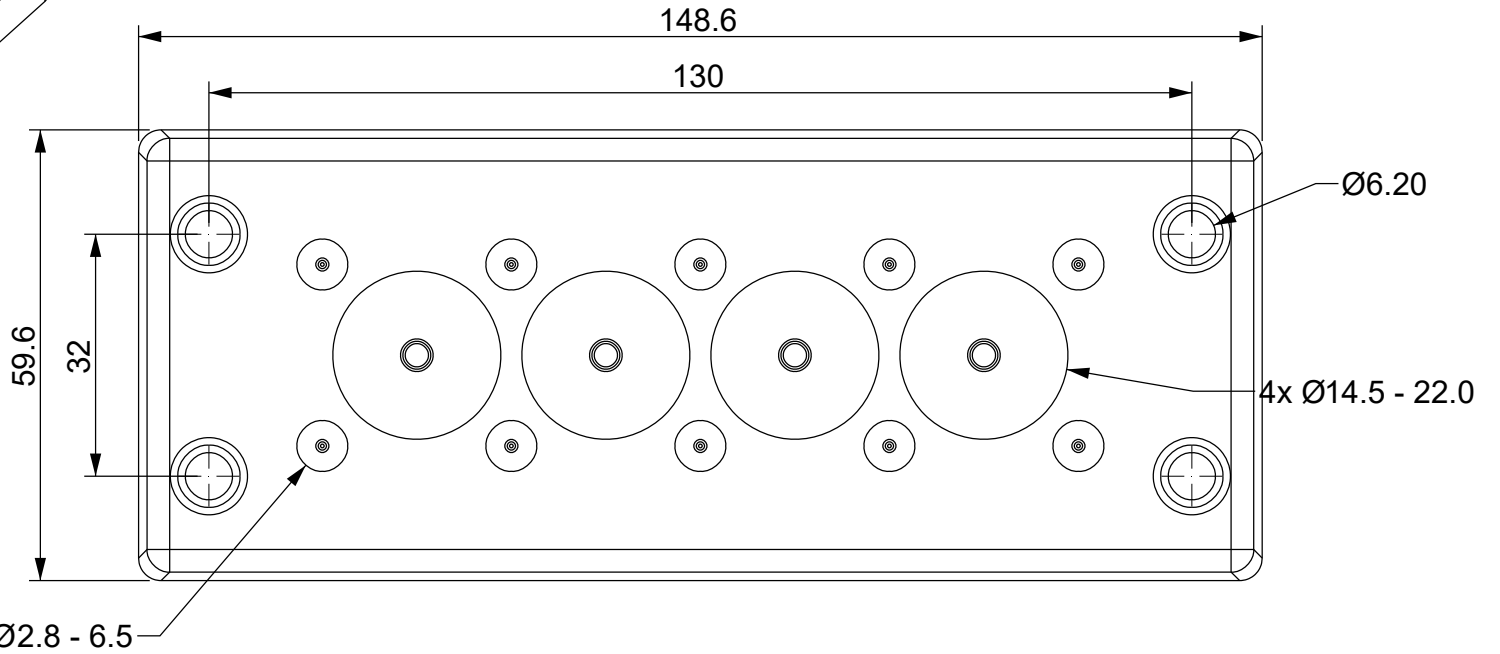
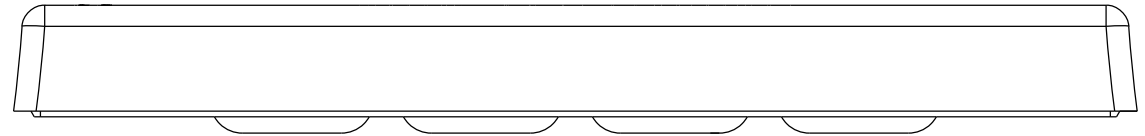
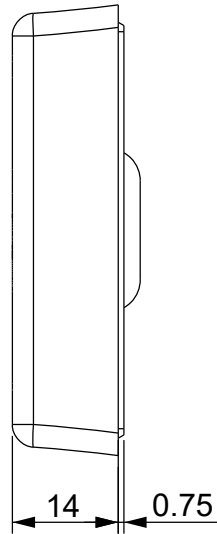
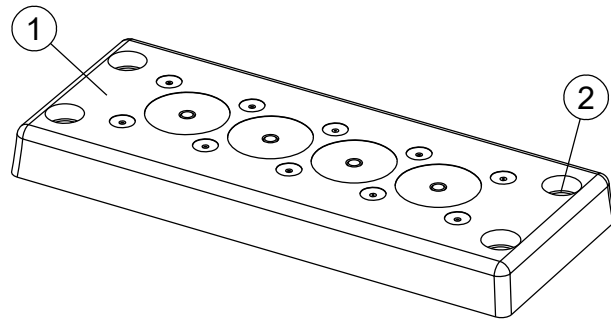

Id	Description	Material	Q.ty
1	Body	TPE	1
2	Internal frame	PA	1

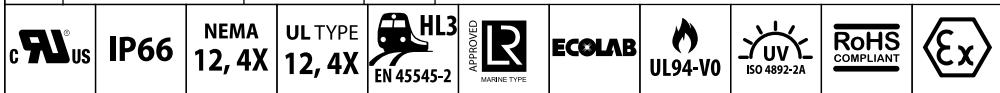

Flammability: UL94-V0, self-extinguishing
Temperature: -40°C ... +105°C
Properties: halogen-free, silicone-free

Recommended cut-out:
112 x 36 mm

Black color version:
DES-PDM-24/14B: 1732013415

Threaded inserts version:
DES-PDM-24/14G FT: 1732212414

ATEX grey version:
DES-PDM-24A/14G: 1732312414

ATEX black version:
DES-PDM-24A/14B: 1732313414

Codice / Code 1732012414			Descrizione / Description DES PDM 24/14			Rev. 003
Materiale / Material See table	Colore / Color Grey	Peso / Weight (g) -	Unità di misura / Measure units mm	Formato / Format A4	Scala / Scale 1:1	
 www.detasultra.com <small>QUESTO DISEGNO E LE SUE INFORMAZIONI SONO STRETTAMENTE RISERVATE DI PROPRIETÀ DETAS SPA. NON UTILIZZARE PER SCOPI DIVERSI DA QUELLI PER CUI SONO STATE FORNITE. DO NOT SCALE DRAWING.</small>			Data / Date 22/11/2021	Numero foglio / Sheet number -	Numero progetto / Project number -	
			Disegn. / Drawn ravezzano@detas.com	Note / Notes -		

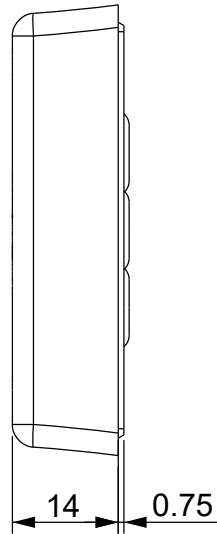
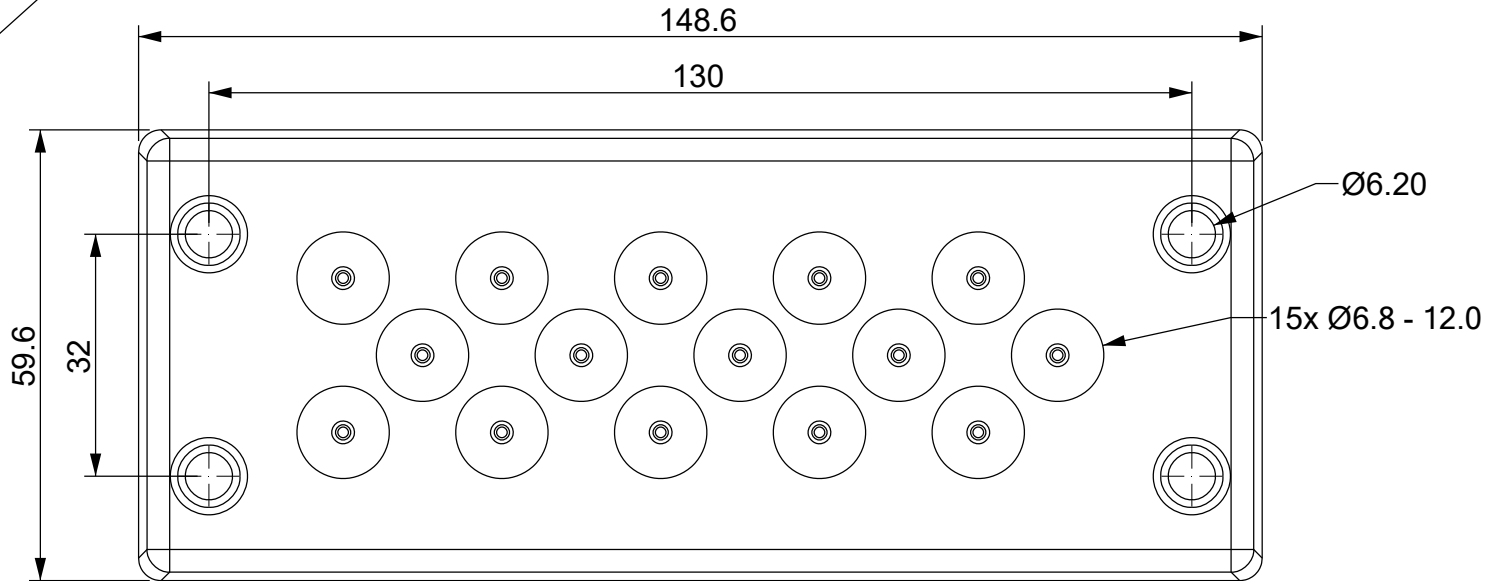
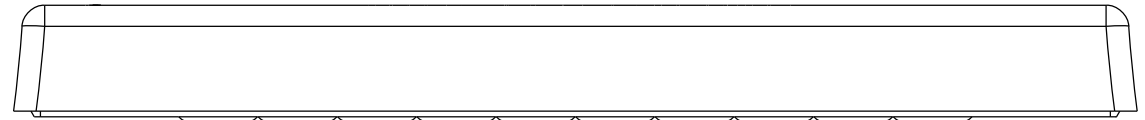
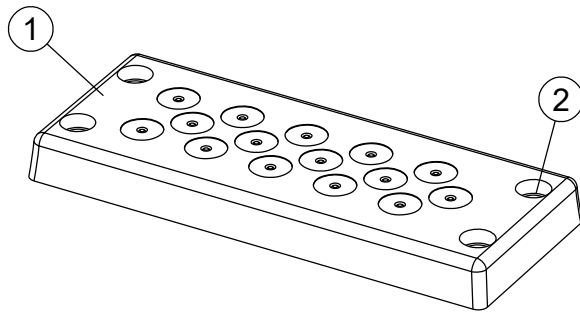

Id	Description	Material	Q.ty
1	Body	TPE	1
2	Internal frame	PA	1

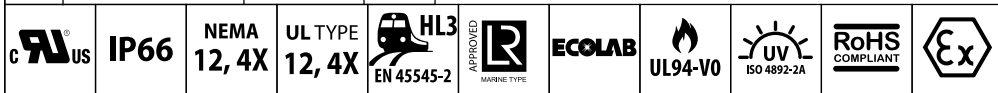

Flammability: UL94-V0, self-extinguishing
Temperature: -40°C ... +105°C
Properties: halogen-free, silicone-free

Recommended cut-out:
112 x 36 mm

Black color version: DES-PDM-24/15B: 1732013416 Threaded inserts version: DES-PDM-24/15G FT: 1732212415 ATEX grey version: DES-PDM-24A/15G: 1732312415 ATEX black version: DES-PDM-24A/15B: 1732313415	Codice / Code		Descrizione / Description			Rev.
	1732012415		DES PDM 24/15			003
	Materiale / Material	Colore / Color	Peso / Weight (g)	Unità di misura / Measure units	Formato / Format	Scala / Scale
See table	Grey	-	mm	A4	1:1	
 www.detasultra.com <small>QUESTO DISEGNO E LE SUE INFORMAZIONI SONO STRETTAMENTE RISERVATE DI PROPRIETÀ DETAS SPA. NON UTILIZZARE PER SCOPI DIVERSI DA QUELLI PER CUI SONO STATE FORNITE. DO NOT SCALE DRAWING.</small>			Data / Date	Numero foglio / Sheet number	Numero progetto / Project number	
			22/11/2021	-	-	
			Disegn. / Drawn	Note / Notes		
			ravezzano@detas.com	-		

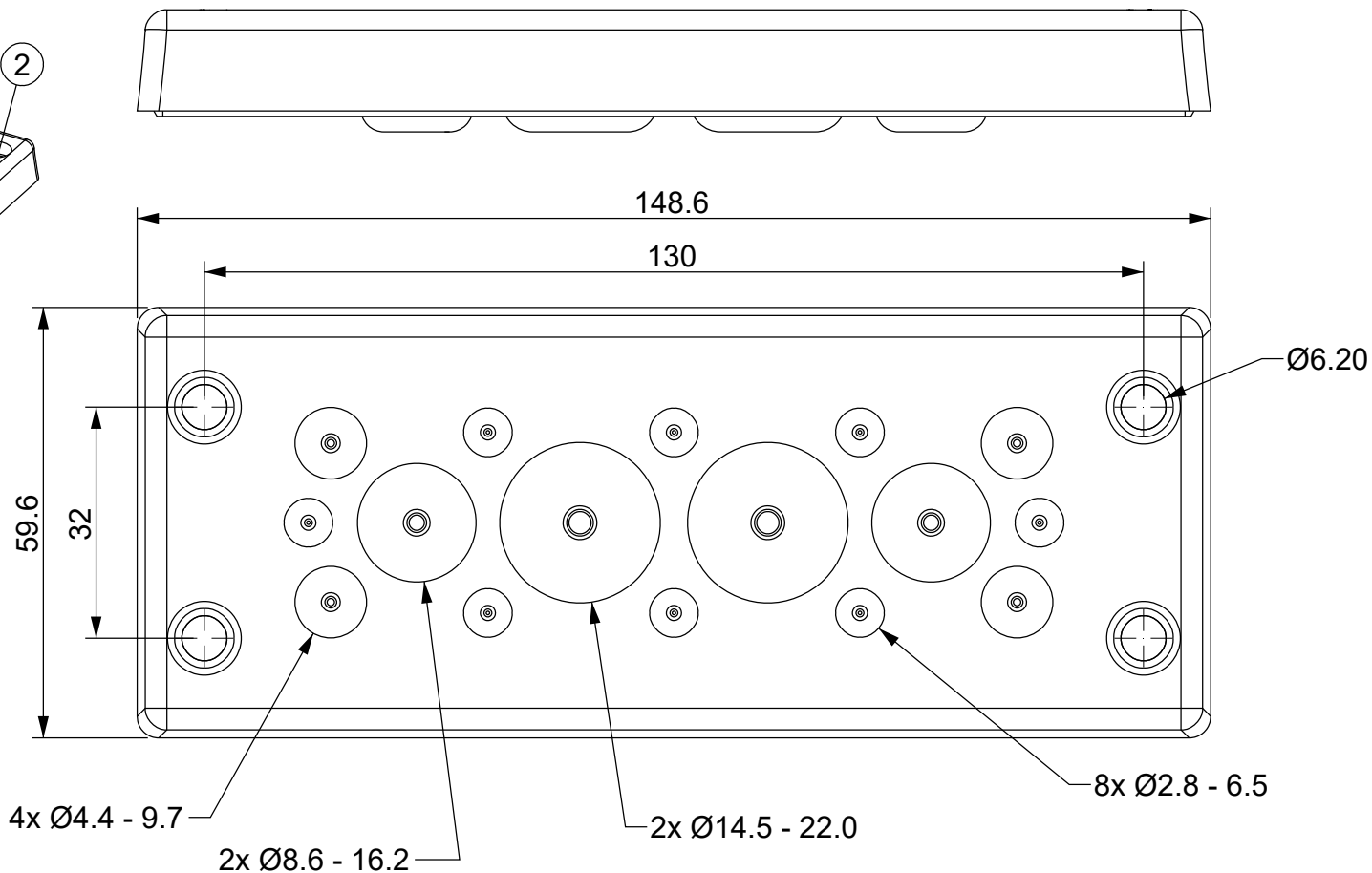
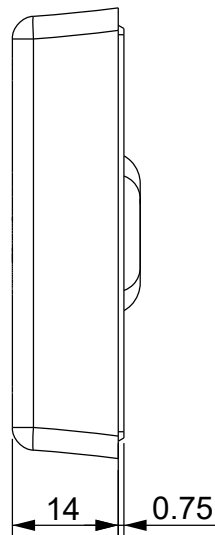
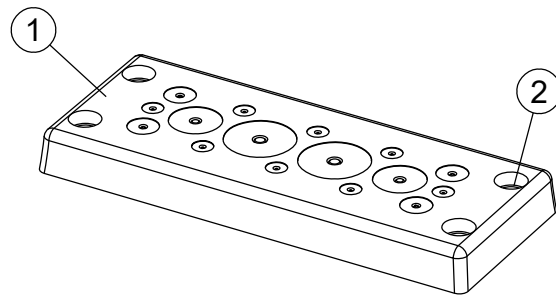

Id	Description	Material	Q.ty
1	Body	TPE	1
2	Internal frame	PA	1

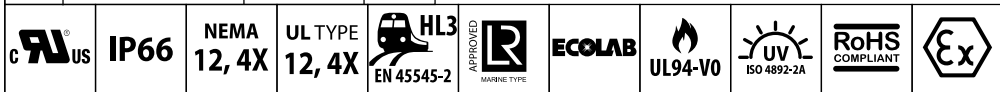

Flammability: UL94-V0, self-extinguishing
Temperature: -40°C ... +105°C
Properties: halogen-free, silicone-free

Recommended cut-out:
112 x 36 mm

Black color version: DES-PDM-24/16B: 1732013417 Threaded inserts version: DES-PDM-24/16G FT: 1732212416 ATEX grey version: DES-PDM-24A/16G: 1732312416 ATEX black version: DES-PDM-24A/16B: 1732313416	Codice / Code		Descrizione / Description			Rev.
	1732012416		DES PDM 24/16			003
	Materiale / Material	Colore / Color	Peso / Weight (g)	Unità di misura / Measure units	Formato / Format	Scala / Scale
See table	Grey	-	mm	A4	1:1	
 www.detasultra.com <small>QUESTO DISEGNO E LE SUE INFORMAZIONI SONO STRETTAMENTE RISERVATE DI PROPRIETÀ DETAS SPA. NON UTILIZZARE PER SCOPI DIVERSI DA QUELLI PER CUI SONO STATE FORNITE. DO NOT SCALE DRAWING.</small>			Data / Date	Numero foglio / Sheet number	Numero progetto / Project number	
			22/11/2021	-	-	
			Disegn. / Drawn	Note / Notes		
			ravezzano@detas.com	-		

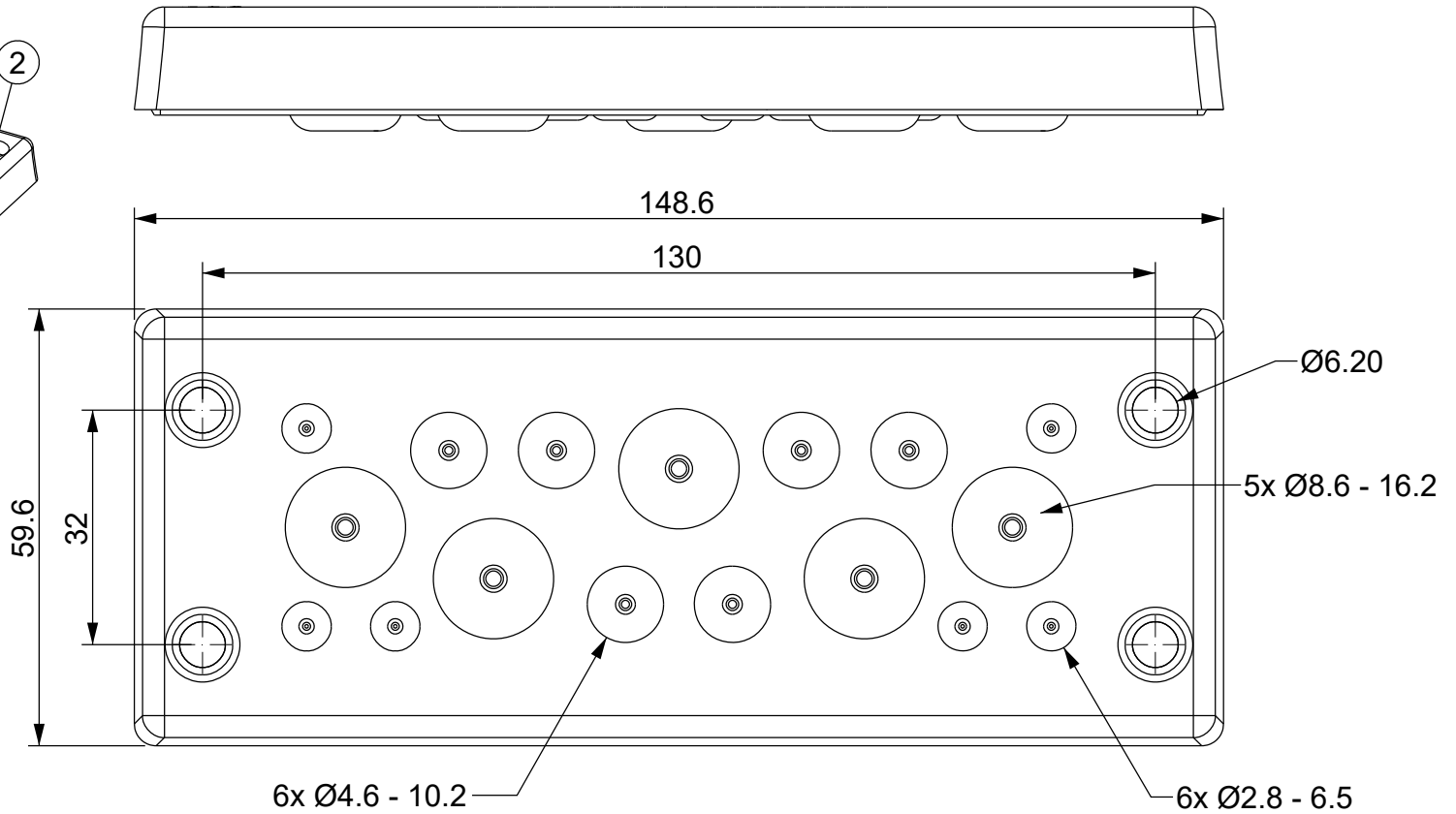
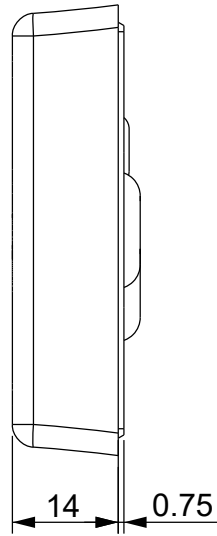
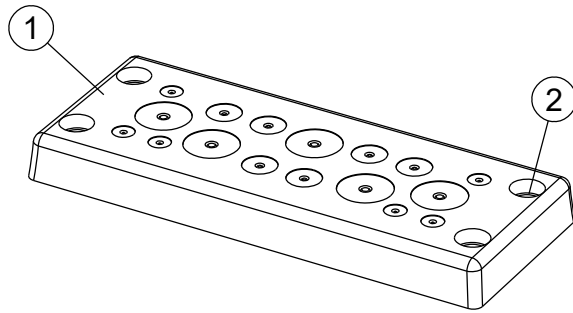

Id	Description	Material	Q.ty
1	Body	TPE	1
2	Internal frame	PA	1

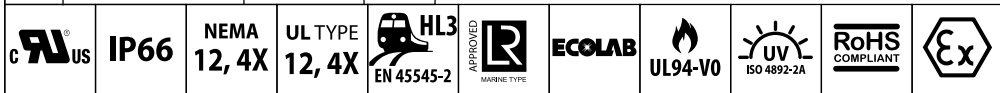

Flammability: UL94-V0, self-extinguishing
Temperature: -40°C ... +105°C
Properties: halogen-free, silicone-free

Recommended cut-out:
112 x 36 mm

Black color version: DES-PDM-24/17B: 1732013418 Threaded inserts version: DES-PDM-24/17G FT: 1732212417 ATEX grey version: DES-PDM-24A/17G: 1732312417 ATEX black version: DES-PDM-24A/17B: 1732313417	Codice / Code		Descrizione / Description			Rev.
	1732012417		DES PDM 24/17			003
	Materiale / Material	Colore / Color	Peso / Weight (g)	Unità di misura / Measure units	Formato / Format	Scala / Scale
See table	Grey	-	mm	A4	1:1	
 www.detasultra.com <small>QUESTO DISEGNO E LE SUE INFORMAZIONI SONO STRETTAMENTE RISERVATE DI PROPRIETÀ DETAS SPA. NON UTILIZZARE PER SCOPI DIVERSI DA QUELLI PER CUI SONO STATE FORNITE. DO NOT SCALE DRAWING.</small>			Data / Date	Numero foglio / Sheet number	Numero progetto / Project number	
			22/11/2021	-	-	
			Disegn. / Drawn	Note / Notes		
			ravezzano@detas.com	-		

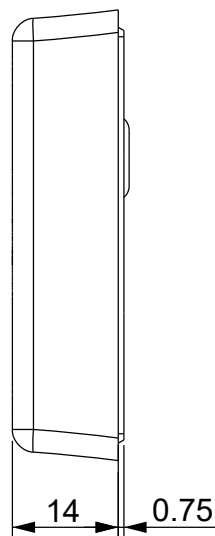
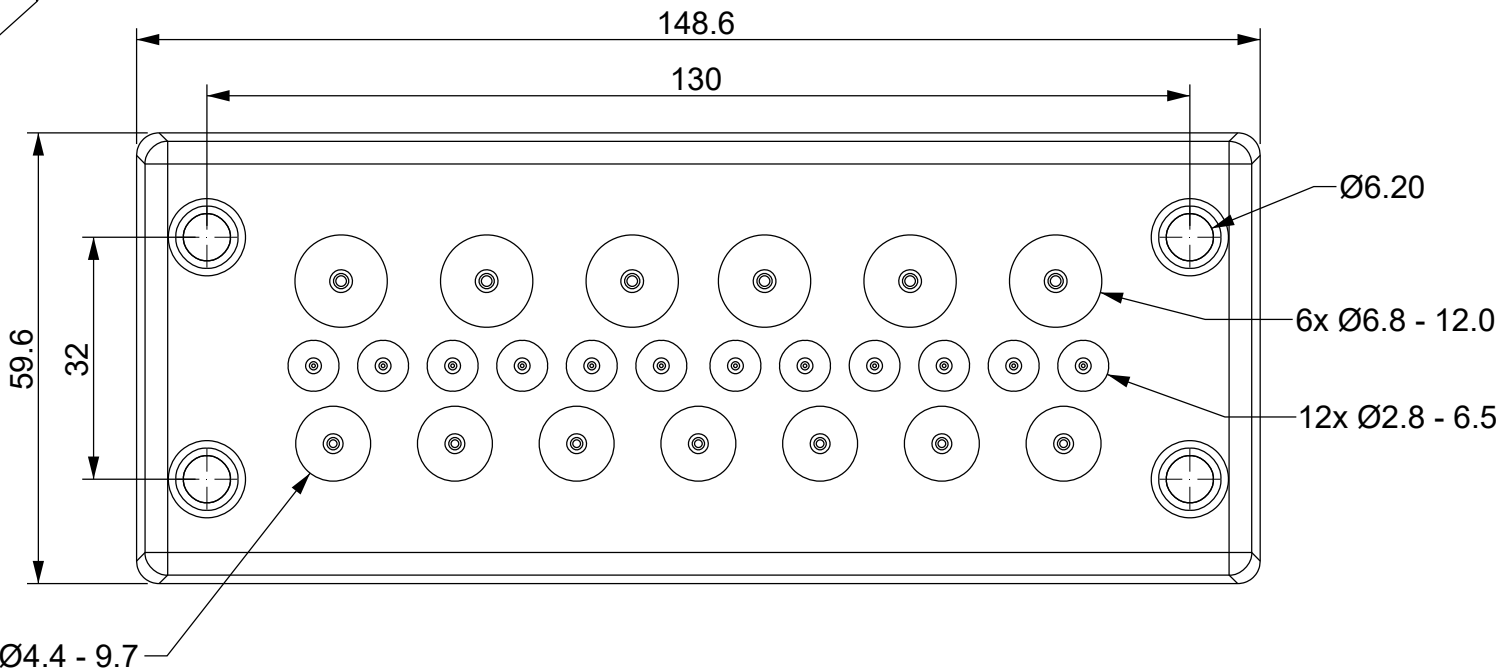
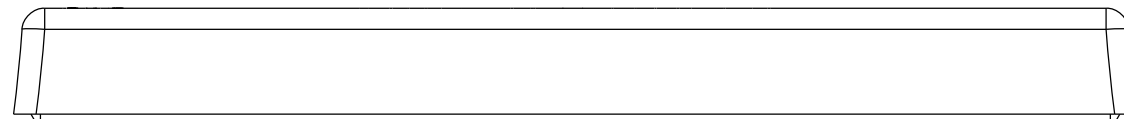
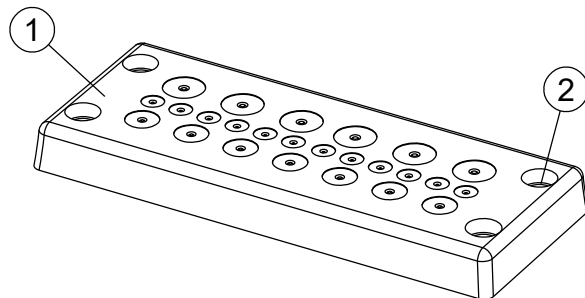

Id	Description	Material	Q.ty
1	Body	TPE	1
2	Internal frame	PA	1

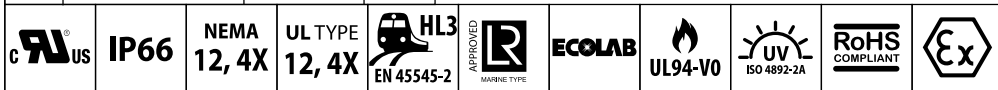

Flammability: UL94-V0, self-extinguishing
Temperature: -40°C ... +105°C
Properties: halogen-free, silicone-free

Recommended cut-out:
112 x 36 mm

Black color version: DES-PDM-24/25B: 1732013426 Threaded inserts version: DES-PDM-24/25G FT: 1732212425 ATEX grey version: DES-PDM-24A/25G: 1732312425 ATEX black version: DES-PDM-24A/25B: 1732313425	Codice / Code		Descrizione / Description			Rev.
	1732012425		DES PDM 24/25			003
	Materiale / Material	Colore / Color	Peso / Weight (g)	Unità di misura / Measure units	Formato / Format	Scala / Scale
See table	Grey	-	mm	A4	1:1	
 www.detasultra.com <small>QUESTO DISEGNO E LE SUE INFORMAZIONI SONO STRETTAMENTE RISERVATE DI PROPRIETÀ DETAS SPA. NON UTILIZZARE PER SCOPI DIVERSI DA QUELLI PER CUI SONO STATE FORNITE. DO NOT SCALE DRAWING.</small>			Data / Date	Numero foglio / Sheet number	Numero progetto / Project number	
			22/11/2021	-	-	
			Disegn. / Drawn	Note / Notes		
			ravezzano@detas.com	-		

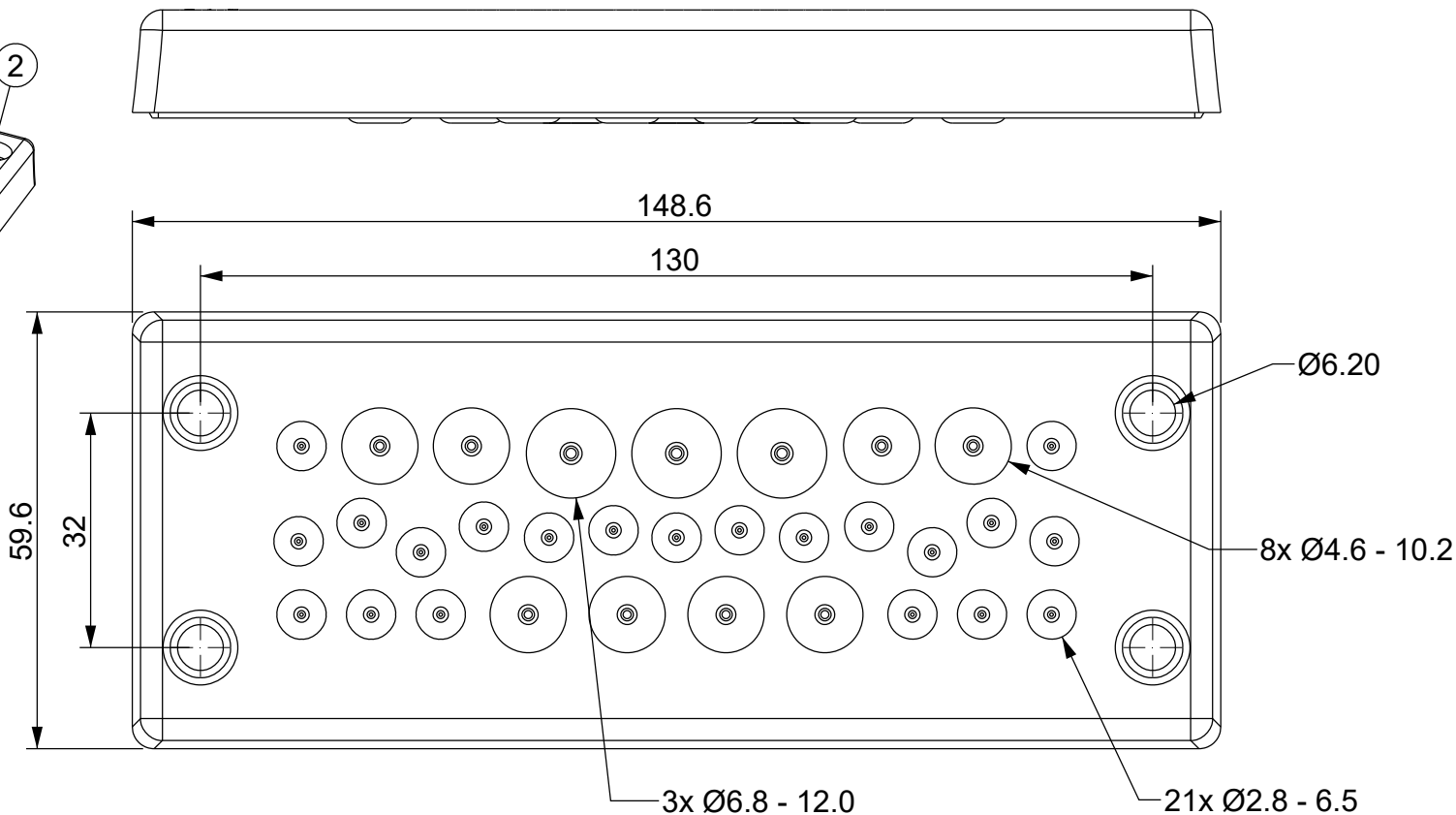
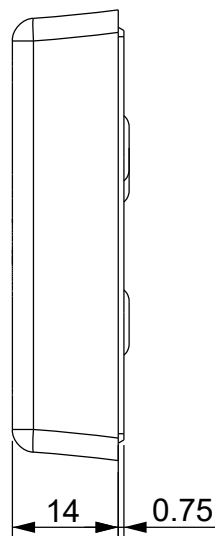
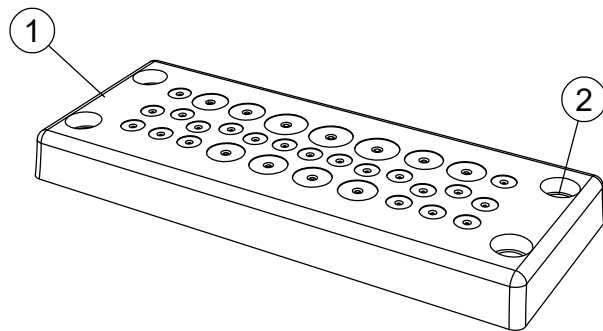

Id	Description	Material	Q.ty
1	Body	TPE	1
2	Internal frame	PA	1

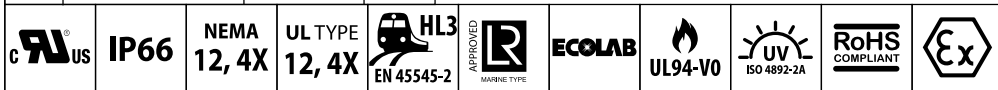

Flammability: UL94-V0, self-extinguishing
Temperature: -40°C ... +105°C
Properties: halogen-free, silicone-free

Recommended cut-out:
112 x 36 mm

Black color version: DES-PDM-24/32B: 1732013433 Threaded inserts version: DES-PDM-24/32G FT: 1732212432 ATEX grey version: DES-PDM-24A/32G: 1732312432 ATEX black version: DES-PDM-24A/32B: 1732313432	Codice / Code		Descrizione / Description			Rev.
	1732012432		DES PDM 24/32			003
	Materiale / Material	Colore / Color	Peso / Weight (g)	Unità di misura / Measure units	Formato / Format	Scala / Scale
See table	Grey	-	mm	A4	1:1	
 www.detasultra.com <small>QUESTO DISEGNO E LE SUE INFORMAZIONI SONO STRETTAMENTE RISERVATE DI PROPRIETÀ DETAS SPA. NON UTILIZZARE PER SCOPI DIVERSI DA QUELLI PER CUI SONO STATE FORNITE. DO NOT SCALE DRAWING.</small>			Data / Date	Numero foglio / Sheet number	Numero progetto / Project number	
			22/11/2021	-	-	
			Disegn. / Drawn	Note / Notes		
			ravezzano@detas.com	-		

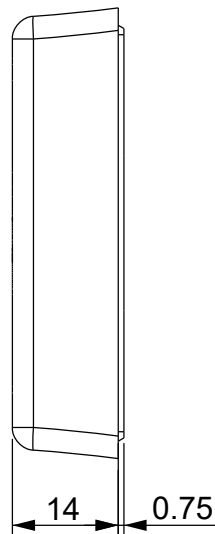
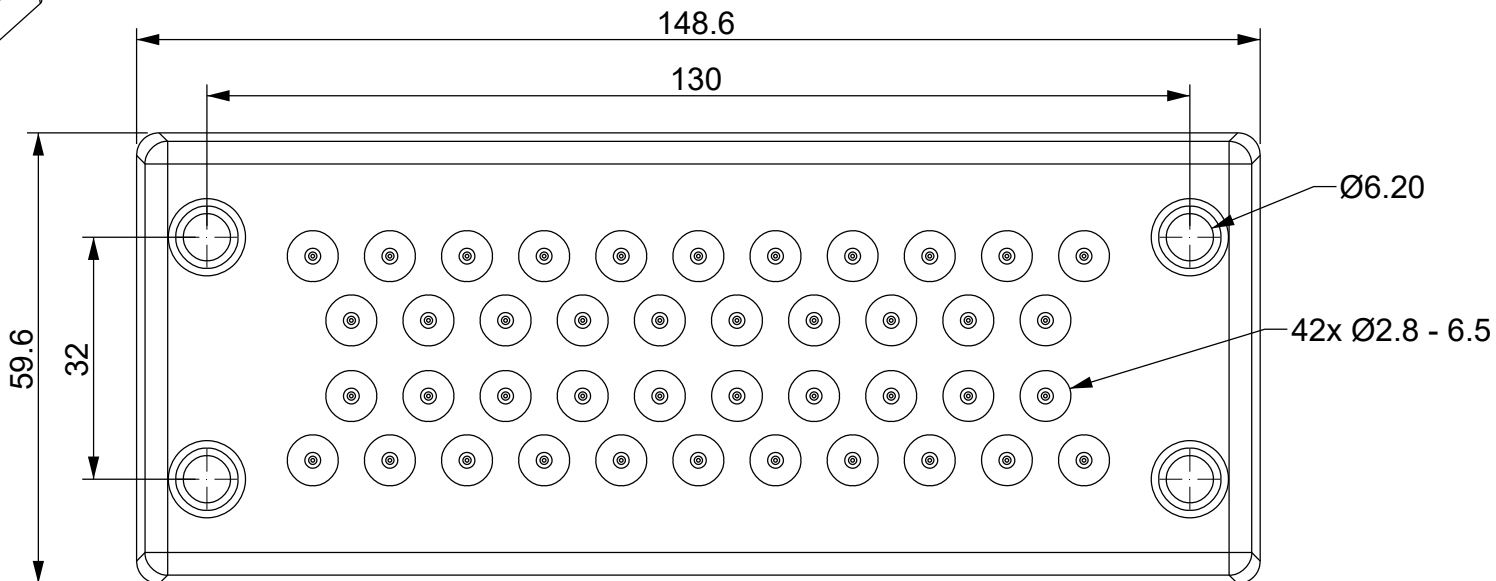
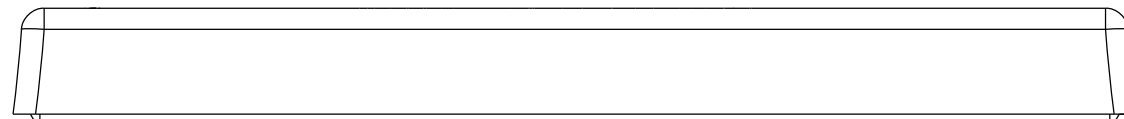
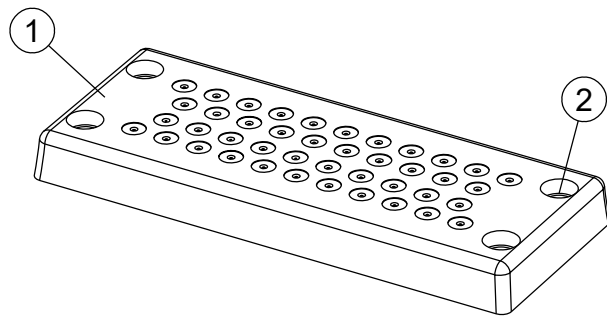

Id	Description	Material	Q.ty
1	Body	TPE	1
2	Internal frame	PA	1

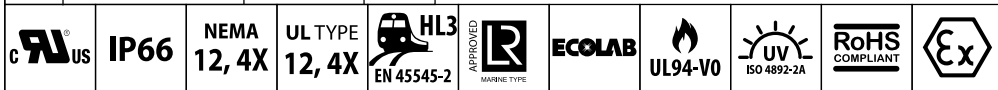

Flammability: UL94-V0, self-extinguishing
Temperature: -40°C ... +105°C
Properties: halogen-free, silicone-free

Recommended cut-out:
112 x 36 mm

Black color version: DES-PDM-24/42B: 1732013443 Threaded inserts version: DES-PDM-24/42G FT: 1732212442 ATEX grey version: DES-PDM-24A/42G: 1732312442 ATEX black version: DES-PDM-24A/42B: 1732313442	Codice / Code		Descrizione / Description			Rev.
	1732012442		DES PDM 24/42			003
	Materiale / Material	Colore / Color	Peso / Weight (g)	Unità di misura / Measure units	Formato / Format	Scala / Scale
See table	Grey	-	mm	A4	1:1	
 www.detasultra.com <small>QUESTO DISEGNO E LE SUE INFORMAZIONI SONO STRETTAMENTE RISERVATE DI PROPRIETÀ DETAS SPA. NON UTILIZZARE PER SCOPI DIVERSI DA QUELLI PER CUI SONO STATE FORNITE. DO NOT SCALE DRAWING.</small>			Data / Date	Numero foglio / Sheet number	Numero progetto / Project number	
			22/11/2021	-	-	
			Disegn. / Drawn	Note / Notes		
			ravezzano@detas.com	-		

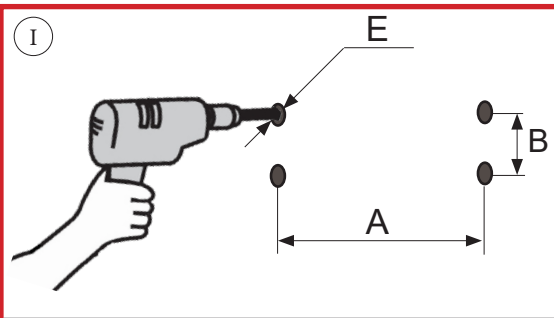

Manual for:
 DES PDM 24 - DES PDM S - DES PDM Q

	A mm	B mm	C ± 0,5mm	D ± 0,5mm	E mm
DES PDM 24	130	32	112	36	Ø5 ^{+0.20} _{-0.05}
DES PDM S	130	/	112	18	Ø5 ^{+0.20} _{-0.05}
DES PDM Q	58	32	46	46	Ø5 ^{+0.20} _{-0.05}

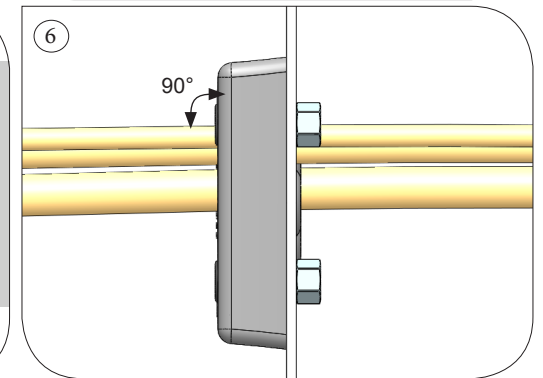
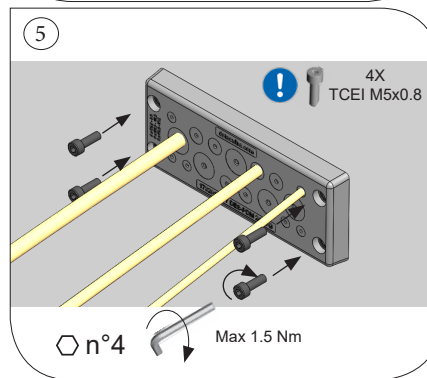
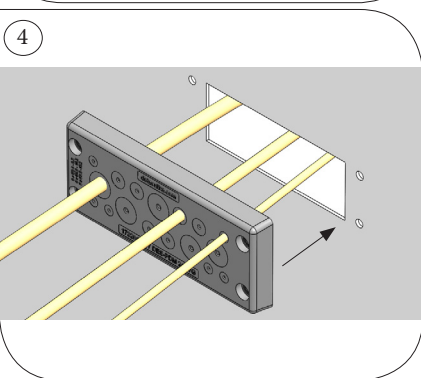
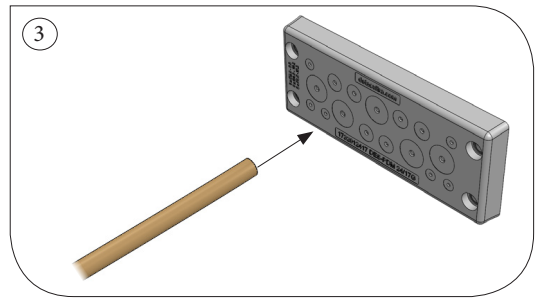
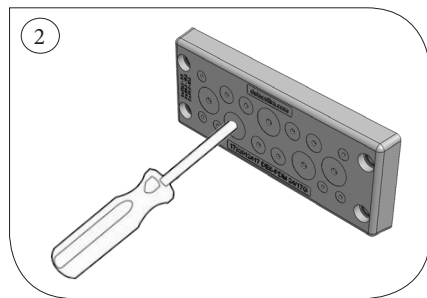
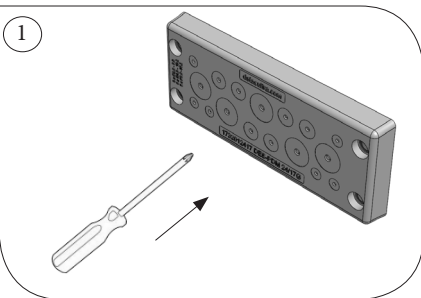
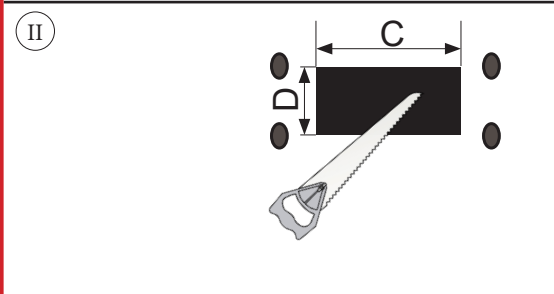

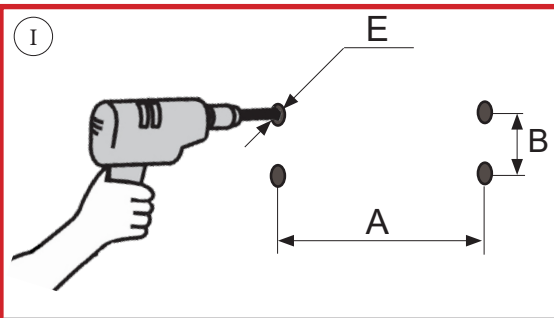

Manual for:
 DES PDM 24 FT - DES PDM S FT - DES PDM Q FT

	A mm	B mm	C ± 0,5mm	D ± 0,5mm	E mm
DES PDM 24	130	32	112	36	Ø5 ^{+0.20} _{-0.05}
DES PDM S	130	/	112	18	Ø5 ^{+0.20} _{-0.05}
DES PDM Q	58	32	46	46	Ø5 ^{+0.20} _{-0.05}

